

GENERAL DESCRIPTION

C9318E1 is a CMOS LSI calculator chip with 8 digits arithmetic operations, single memory, extraction-of-square-root percentage calculation and punctuation function, designed for triplex LCD application with solar cell power supply.

FUNCTIONS

- Four standard functions (+, -, x, /).
- Auto-constant calculations (constant : multiplicand, divisor, addend and subtrahend).
- Square and reciprocal calculations.
- Mark-up and mark-down calculations.
- Extraction of square root.
- Percentage calculations.
- Chain multiplication and division.
- Power calculations.
- Rough estimate calculations.
- Punctuation comma display.

FUNCTIONAL DESCRIPTION

a. Floating point system

- i) 8 digits floating decimal point system, with leading zero suppression, Zero shift.
- ii) Symbols : '-' negative number indicator.
: 'E' Error status indicator.
: '9' punctuation comma
: 'M' Non-zero memory indicator.

b. Error Detections

- i) System errors occur when :
 - The integral part of any calculation result exceeds 8 digits.
 - The integral part of any memory calculation result exceeds 8 digits.
 - The integral part of any addend or subtrahend to memory exceed 8 digits.
 - The integral part of a mark-up or mark-down calculation result exceeds 8 digits.
 - The division by zero.
 - The extraction of square root of a negative number.
- ii) Rough estimate calculation error
 - The integral part of the result of any standard functions, percentage, square, reciprocal or power calculations exceeds 8 digits and is equal to 16 digits or less.

c. Error Indication

- i) System error

APPLICATION

This specification contains complete informations of functional operations, electrical characteristics, packaging, and crating requirements of C9318E1.

FEATURES

- Accumulating memory : M+, M-, RM, CM, RM/CM.
- Rollover capability.
- Floating decimal.
- Overflow indication.
- 8-digit LCD triplex.
- Automatic power off function.

'0' is indicated in the 1-digit position and 'E' in the sign indicator position.

ii) Rough estimate calculation error

The high-order 8 digits of a calculation result is indicated together with 'E'. The decimal point is indicated in the position corresponding to a calculation result times 10^{-8} , and no zero shift is performed.

d. Error Release

- i) System error can be released by the ON/C or ON/CE key.
- ii) Rough estimate calculation error can be released by the ON/C, ON/CE, CE key.

e. Number Entry

Numerical can be entered up to 8 digits, entries that equal to 9 digits or more will be ignored.

f. Memory Protection

The memory contents before any error detection are protected.

g. Memory Indication

If the memory contents is non-zero, 'M' is indicated in the memory indicator position.

h. Double Key Depression

The order of priority when two keys are being depressed simultaneously is as follows :

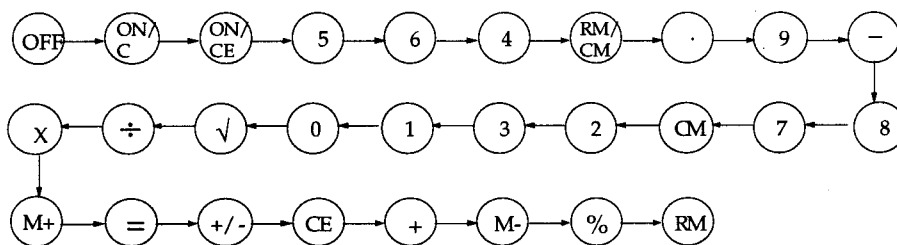

When the OFF and ON/C key are depressed simultaneously, the OFF key is given priority.

i. Key bounce protection

- i) Front edge : down to 1 word and up to about 3 words.
- ii) Trailing edge : 9 words. (1 word is 3.3ms when display frequency is $F_d=100\text{Hz}$.)

j. Auto Power Off

Power automatically turns off after 9 - 11 minutes pass from the last key press.

k. Clear Operation

All operations except memory content are cleared by ON/C key.

ABSOLUTE MAXIMUM RATINGS

Parameters	Symbol	Value	Unit	Note
Terminal voltage	V _{DD}	- 0.3 ~ + 2.0	V	1
	V _{IN}	- 0.3 ~ V _{DD} + 0.3	V	1
Solar Supply Voltage	V _{SB}	1.1 ~ 3.0	V	2
	V _{GG} (LIM)	1.1 ~ 1.8	V	3

Note 1 : Maximum voltage on any pin is referenced to GND.

Note 2 :V_{SB} is solar supply voltage.

Note 3 :V_{GG} (lim) is limited voltage.

ELECTRICAL CHARACTERISTICS

(Ta = 25°C, V_{DD} = 1.5V unless otherwise specified)

Parameter	Symbol	Min.	Typ.	Max.	Unit	Test Condition	Note
Input Voltage	V _{IH}	V _{DD} -0.4	--	--	V	--	4
	V _{IL}	--	--	0.4	V	--	
Input Current	I _{IH}	--	--	1	μA	V _{IN} = V _{DD}	5
	I _{IL}	0.3	1	3	μA	V _{IN} = 0V	
Output Voltage 1	V _{OH}	V _{DD} -0.15	--	--	V	No load	6
	V _{OL}	--	--	0.15	V	I _{OUT} = 15μA	
Output Voltage 2	V _{OA}	2.8	2.95	--	V	No load	7
	V _{OB}	1.3	1.5	1.7	V	No load	
	V _{OC}	--	0	0.2	V	No load	
Display Frequency	F _d	40	55	65	Hz	V _{DD} = 1.3V while display is ON.	7
Dissipation Current	I _{OFF}	--	--	0.1	μA	Display is OFF	8
	I _{DIS}	--	4.2	6	μA	V _{DD} = 1.3V while display is on.	9
	I _{OP}	--	6.8	--	μA	V _{DD} = 1.1V , while operation.	10

Note 4 : Applies to Pins K2 ~ K6.

Note 5 : Applies to Pins K2 ~ K6.

Note 6 : Applies to P1,P2, A2X ~ A5X.

Note 7 : Applies to H1 ~ H3, A1 ~ A8, B1 ~ B8, C1 ~ C8.

Note 8 : Measured by the test circuit below after power supply automatically turns off.

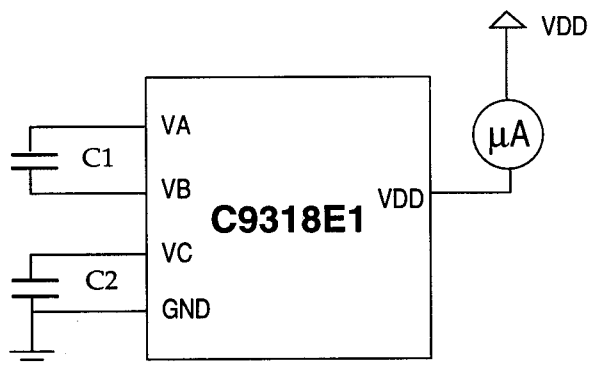

Note 9 : Measured by the test circuit while "0" is being displayed after auto - clear operation and while key is not being depressed.

Note 10 : Measured by the test circuit while operation is being made by ON/C key and while key is not being depressed.

LCD BACKPLANE OUTPUT WAVEFORM

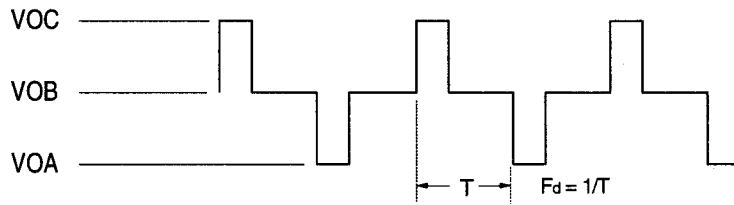

DISPLAY FONTS

a. Numerical Font



b. Sign Font

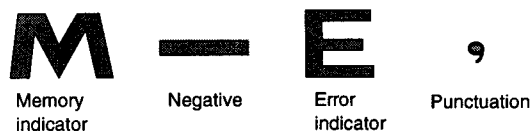

LCD CONNECTOR

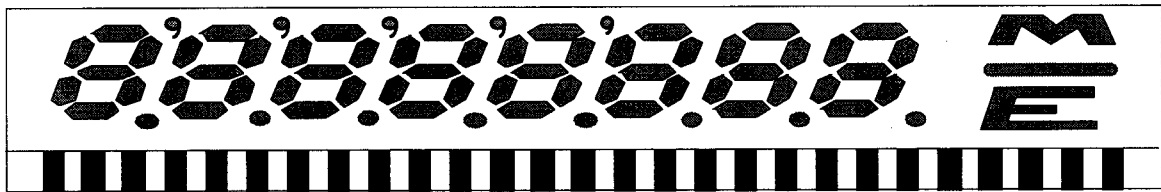

H2 H3 C8 B8 A8 C7 B7 A7 C6 B6 A6 C5 B5 A5 C4 B4 A4 C3 B3 A3 C2 B2 A2 C1 B1 A1 H1

LCD Panel

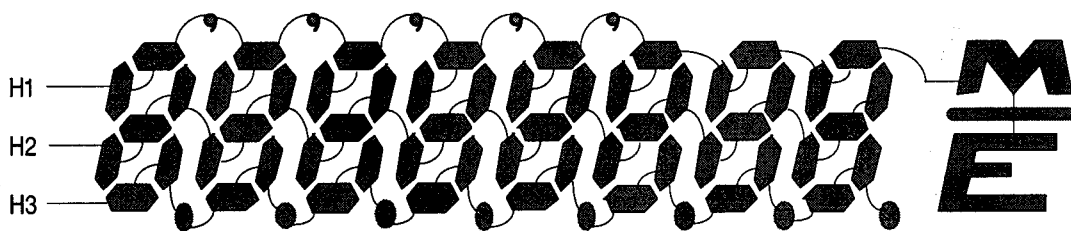

Backplanes Connection

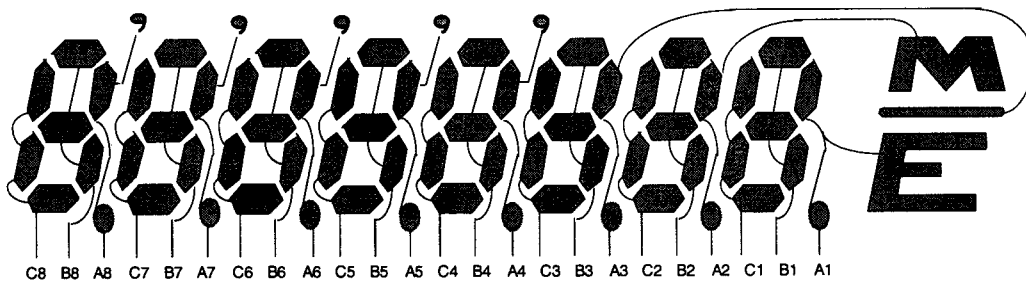

Segment Connection

PIN DESCRIPTION

Pin No.	Signal	I/O	Description	Pin No.	Signal	I/O	Description
1	VSB	I	Solar Battery	24	B7	O	Display output.
2	VOP	I	Option Pin	25	C7	O	Display output.
3	VDD	-	Power supply.	26	A8	O	Display output.
4	H1	O	Display output.	27	B8	O	Display output.
5	A1	O	Display output.	28	C8	O	Display output.
6	B1	O	Display output.	29	H2	O	Display output.
7	C1	O	Display output.	30	H3	O	Display output.
8	A2	O	Display output.	31	GND	-	Ground.
9	B2	O	Display output.	32	VC	O	Cap terminal for voltage step-up.
10	C2	O	Display output.	33	VA	O	Cap terminal for voltage step-up.
11	A3	O	Display output.	34	VB	O	Cap terminal for voltage step-up.
12	B3	O	Display output.	35	CGin	I	Input terminal for CG.
13	C3	O	Display output.	36	K3	I	Key input.
14	A4	O	Display output.	37	K2	I	Key input.
15	B4	O	Display output.	38	A2X	O	Strobe output.
16	C4	O	Display output.	39	A3X	O	Strobe output.
17	A5	O	Display output.	40	A4X	O	Strobe output.
18	B5	O	Display output.	41	A5X	O	Strobe output.
19	C5	O	Display output.	42	P2	O	Strobe output.
20	A6	O	Display output.	43	P1	O	Strobe output.
21	B6	O	Display output.	44	K5	I	Key input.
22	C6	O	Display output.	45	K6	I	Key input.
23	A7	O	Display output.	46	K4	I	Key input.

APPLICATION DIAGRAM For DUAL POWER SUPPLY

